

EchoBeam® LR80

80 GHz Radar Liquid and Solids Level Transmitter



Performance

Offered in four models, EchoBeam® is the most reliable and easy-to-use non-contact level sensor. Flowline's 80 GHz radar technology is unaffected by most media, process or environmental factors, and our intuitive LevelTap™ App makes configuration simple.

	LR80	LR81	LR83	LR85
Range:	Liquid: 32.8' (10m) Solids: 16.4' (5m)	Liquid: 98.4' (30m) Solids: 49.2' (15m)	Liquid: 98.4' (30m) Solids: 49.2' (15m)	Liquid: 393.7' (120m) Solids: 196.8' (60m)
Accuracy:	±5mm	±2mm	±2mm	±2mm
Output:	4-20 mA	4-20 mA w/HART, Modbus or SDI-12	4-20 mA w/HART or Modbus	4-20 mA w/HART or Modbus
Class.:	GP	GP	GP	GP
Max Temp.:	60° C.	80° C.	100° C.	120° C.
Termination:	Cable	Cable	Conduit	Conduit
Application:	Basic	Challenging	Challenging	Extreme

Application

The LR80 general purpose 80 GHz radar sensor provides continuous level measurement up to 32.8' (10m) for liquids or 16.4' (5m) for solids with a 4-20 mA signal output. The sensor is wirelessly configured over Bluetooth via our LevelTap™ App which enables you to see the level, verify the status, and manage the settings of connected sensors from the safety of the ground or nearby catwalk. The sensor measures liquid and solids media with a dielectric constant value ≥ 1.6, such as water, chemical or petroleum-based liquids, and pellet, grain, powder or aggregate solids. Select this sensor for tank, sump, lift station, weir, canal, reservoir, bin, conveyor or transfer station applications.

Features

- 80 GHz technology provides reliable, maintenance-free operation
- Measures level height, air gap, tank volume or open channel flow
- Rugged PVDF antenna and enclosure for corrosive liquid or solids
- IP68 rated sensor for harsh outdoor or below grade installations
- Sealed 10m PVC jacketed cable for corrosive level environments
- Zero dead band maximizes the potential fill capacity of small tanks
- Optionally measures through top wall of plastic or fiberglass tanks
- Bluetooth wireless configuration via the LevelTap™ mobile App
- Lowest cost radar sensor for your basic level requirements

Configuration

Download the free LevelTap™ App at the Apple Store, Google Play or Baidu Store, register and go to Demo Sensors. There you can view level status and step-by-step or advanced configuration examples prior to sensor purchase.



LM50-3S21 SS bracket

Offered with 32.8' (10m) PVC cable and a variety of fitting accessories.

Natural contaminant free PVDF antenna.

Versatile compact sensor with zero dead band is ideal for small or large tanks and sumps.

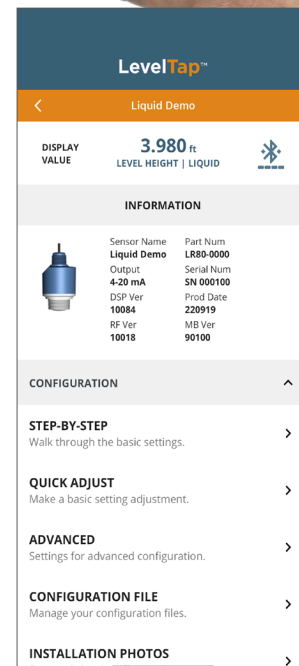

EchoBeam® LR80

80 GHz Radar Liquid and Solids Level Transmitter



Specifications

Maximum range:	Liquid: 32.8' (10m) with media dielectric ≥ 1.6 and no agitation Solids: 16.4' (5m) with media dielectric ≥ 6 and no dust
Frequency:	80 GHz., W-band, FMCW
Accuracy:	0.4m to 10m: ± 5 mm 0.00m to 0.39m: ± 10 mm
Dead band:	0" (0mm)
Beam angle:	8°
Min. dielectric:	≥ 1.6
Bluetooth version:	Bluetooth 5.0
Bluetooth range:	26.2' (8m)
Configuration:	LevelTap™ App (IOS & Android)
Memory:	Non-volatile
Signal output:	4-20 mA, two-wire
Max. signal dist.:	1,000' (304m)
Signal fail-safe:	Selectable high, low or hold last value
Supply voltage:	12-30 VDC
Max. consumption:	22.5 mA
Process temp.:	F: -40° to 140° C: -40° to 60°
Temp. comp.:	Automatic
Storage temp.:	F: -40° to 176° C: -40° to 80°
Pressure:	-14.5 to 43.5 psi (-1 to 3 bar)
Enclosure rating:	Type 6P (IP68)
Encl. material:	PVDF (pigmented polyvinylidene fluoride)
Antenna material:	PVDF (natural polyvinylidene fluoride)
Cable jacket mat.:	PVC (polyvinyl chloride)
Cable seal mat.:	Viton GLT (fluoroelastomer)
Cable orientation:	Vertical
Shielded cable:	2-conductor
Cable length:	32.8' (10m)
Conduit connect.:	-- 0 _: 1" NPT -- 1 _: 1" G
Process mount:	-- 0 _: 1 1/2" NPT -- 1 _: 1 1/2" G
Mount gasket:	-- 0 _: N/a -- 1 _: Viton GLT (fluoroelastomer)
Classification:	General purpose (cCSAus)
Approvals:	C22.2 No. 61010-1-12
Compliance:	FCC: Part 15.256, 15.209, 15C ISED IC: RSS-102, RSS-211, RSS-247 UKCA RER 2017: 6(1)(a), 6(1)(b), 6(2) CE/RED 2014/53/EU: EN 302 372, EN 302 729, EN 301 489-1, -33, EN 300 328 SRRC: (No. [2002] 353) RoHS, REACH, CRN, conflict minerals

Dimensions

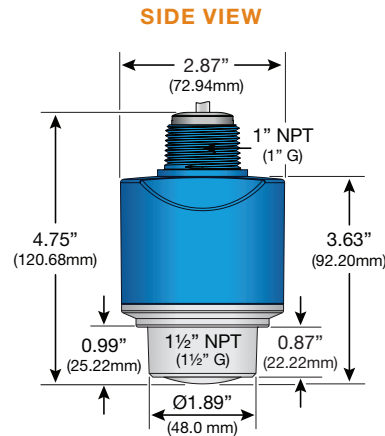

FITTINGS

LM53-4855 PVC adhesive fitting

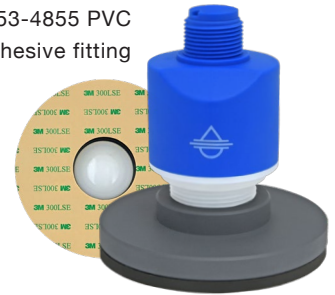

ADAPTERS

LM53-2440 PTFE capped adapter



BRACKETS

Installation

Flowline offers a variety of installation solutions including adhesive fittings for non-invasive measurement through flat mount plastic or fiberglass tank tops; capped PTFE fitting adapters for extremely corrosive media; and adjustable 316 brackets for side wall or above tank mounting.

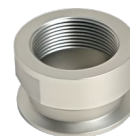

LM53-1S80 SS tri-clamp adapter



LM50-3S22 SS bracket

Ordering

LR80-00 0

PROCESS MOUNT (1) (2)

- 0 1 1/2" NPT
- 1 1 1/2" G with Viton Gasket



LM50-3S21



LM50-3S31



LM50-3S22



LM50-3S32

NOTES

- To mount the sensor to the tank side wall or above an open sump or bin, order the appropriate 316 stainless bracket:
 - Short bracket with 1" NPT lock nut = LM50-3S21
 - Short bracket with 1" G lock nut = LM50-4S21
 - Short bracket with 1 1/2" NPT lock nut = LM50-3S31
 - Short bracket with 1 1/2" G lock nut = LM50-4S31
 - Long bracket with 1" NPT lock nut = LM50-3S22
 - Long bracket with 1" G lock nut = LM50-4S22
 - Long bracket with 1 1/2" NPT lock nut = LM50-3S32
 - Long bracket with 1 1/2" G lock nut = LM50-4S32
- If PVDF is not compatible with your application media or you need a different process mount, go to www.flowline.com/level-fittings-enclosures and view our installation accessories.