

BODY

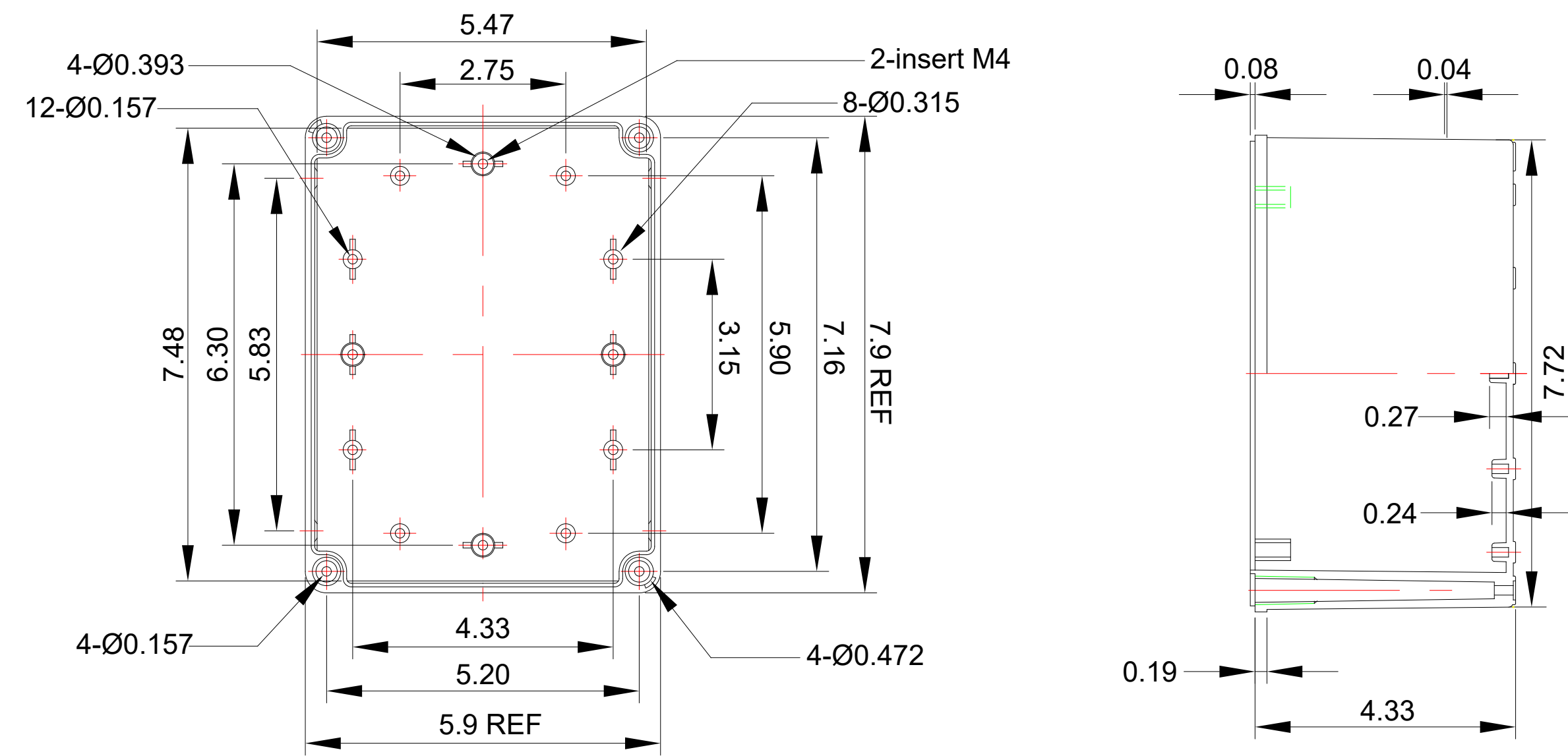

COVER

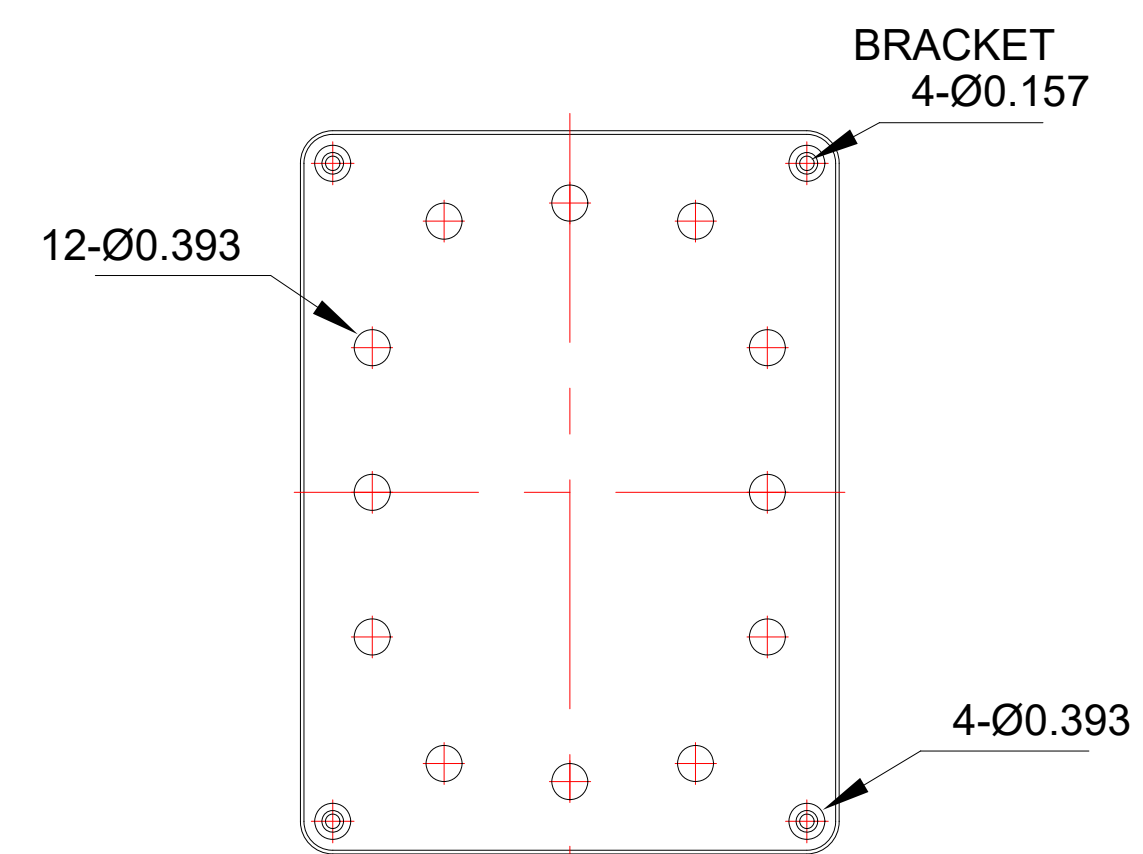
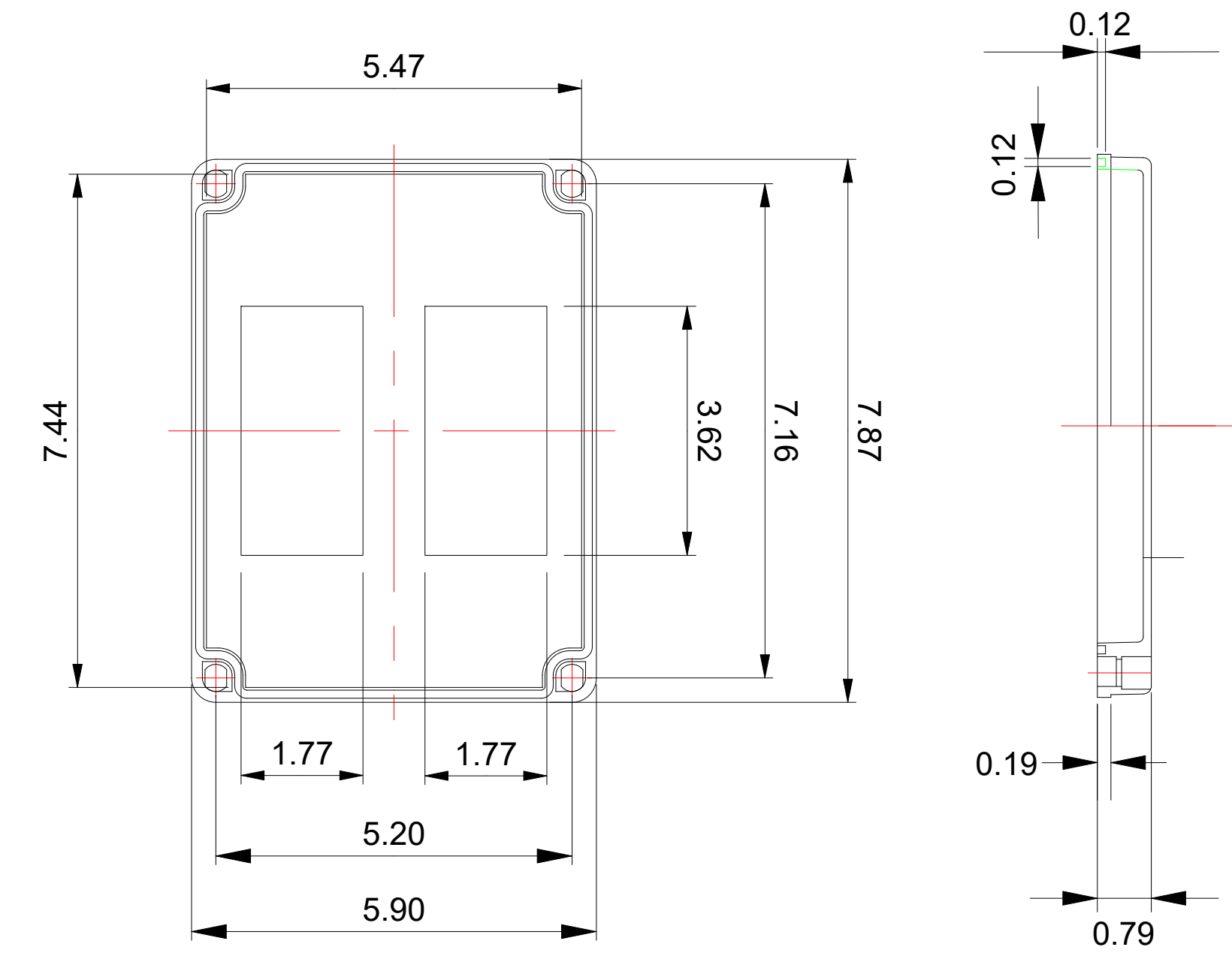

BOTTOM VIEW

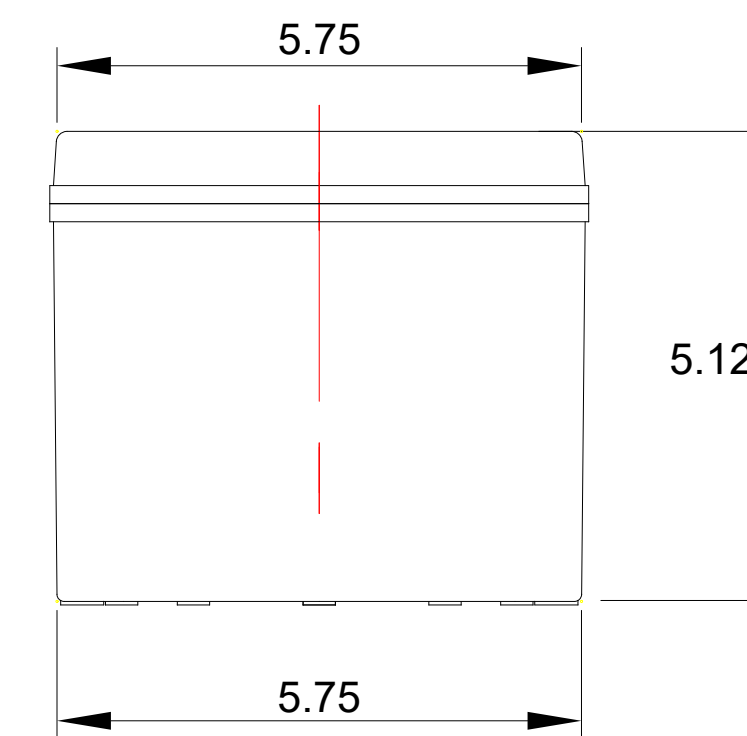

NOTES: ALL DIMENSIONS SHOWN ARE IN INCHES.

DRAWN
P. Colin
02/01/2016

FLOWLINE, INC.
LOS ALAMITOS, CA 90720

LM91-2001 ENCLOSURE
DRAWING FILE
301688 REV A

SCALE 1:2 SIZE D (34 x 22) SHEET 1 OF 1