

Warranty, Service & Repair

To register your product with the manufacturer, go to the Flowline website for on-line registration. The website address is as follows:

www.flowline.com

On-line Warranty Registration can be found under Contact Us on the Navigation Bar along the side of the home page.

If for some reason your product must be returned for factory service, contact Flowline Inc. at (562)598-3015 to receive a Material Return Authorization number (MRA), providing the following information:

1. Part Number, Serial Number
2. Name and telephone number of someone who can answer technical questions related to the product and its application.
3. Return Shipping Address
4. Brief Description of the Symptom
5. Brief Description of the Application

Once you have received a Material Return Authorization number, ship the product prepaid in its original packing to:

Flowline Factory Service
MRA _____
10500 Humbolt Street
Los Alamitos, CA 90720

To avoid delays in processing your repair, write the MRA on the shipping label. Please include the information about the malfunction with your product. This information enables our service technicians to process your repair order as quickly as possible.

FLOWLINE

EchoSafe® Explosion-Proof Ultrasonic Level Transmitter Model XP88 / XP89 Owner's Manual



Version 1.1
© 2007 FLOWLINE Inc.
All rights reserved.
Manual # MN300600 B



WARRANTY

Flowline warrants to the original purchaser of its products that such products will be free from defects in material and workmanship under normal use and service for a period which is equal to the shorter of one year from the date of purchase of such products or two years from the date of manufacture of such products.

This warranty covers only those components of the products which are non-moving and not subject to normal wear. Moreover, products which are modified or altered, and electrical cables which are cut to length during installation are not covered by this warranty.

Flowline's obligation under this warranty is solely and exclusively limited to the repair or replacement, at Flowline's option, of the products (or components thereof) which Flowline's examination proves to its satisfaction to be defective. FLOWLINE SHALL HAVE NO OBLIGATION FOR CONSEQUENTIAL DAMAGES TO PERSONAL OR REAL PROPERTY, OR FOR INJURY TO ANY PERSON.

This warranty does not apply to products which have been subject to electrical or chemical damage due to improper use, accident, negligence, abuse or misuse. Abuse shall be assumed when indicated by electrical damage to relays, reed switches or other components. The warranty does not apply to products which are damaged during shipment back to Flowline's factory or designated service center or are returned without the original casing on the products. Moreover, this warranty becomes immediately null and void if anyone other than service personnel authorized by Flowline attempts to repair the defective products.

Products which are thought to be defective must be shipped prepaid and insured to Flowline's factory or a designated service center (the identity and address of which will be provided upon request) within 30 days of the discovery of the defect. Such defective products must be accompanied by proof of the date of purchase.

Flowline further reserves the right to unilaterally waive this warranty and to dispose of any product returned to Flowline where:

- a. There is evidence of a potentially hazardous material present with product.
- b. The product has remained unclaimed at Flowline for longer than 30 days after dutifully requesting disposition of the product.

THERE ARE NO WARRANTIES WHICH EXTEND BEYOND THE DESCRIPTION ON THE FACE OF THIS WARRANTY. This warranty and the obligations and liabilities of Flowline under it are exclusive and instead of, and the original purchaser hereby waives, all other remedies, warranties, guarantees or liabilities, express or implied. EXCLUDED FROM THIS WARRANTY IS THE IMPLIED WARRANTY OF FITNESS OF THE PRODUCTS FOR A PARTICULAR PURPOSE OR USE AND THE IMPLIED WARRANTY OF MERCHANT ABILITY OF THE PRODUCTS.

This warranty may not be extended, altered or varied except by a written instrument signed by a duly-authorized officer of Flowline, Inc.

SPECIFICATIONS

Step One

Range:	XP88: 8" to 24.6' (20 cm to 7.5 m) XP89: 8" to 32.8' (20 cm to 10 m)
Accuracy:	± 0.2% of max. range
Resolution:	0.079" (2 mm)
Beam width:	3" (7.6 cm) dia.
Dead band:	XP88: 8" (20 cm) XP99: 8" (20 cm)
Display type:	LCD, 6-digits
Display units:	Inch, cm, ft, m, percent
Memory:	Non-volatile
Supply voltage:	18-28 VDC (loop)
Loop resistance:	250Ω max @ 24 VDC
Signal output:	4-20 mA, two-wire
Signal invert:	4-20 mA or 20-4 mA
Calibration:	Push button (3-button)
Fail-safe:	4 mA, 20 mA, 21 mA, 22 mA or hold last
Process Temp.:	F: -4° to 140° C: -20° to 60°
Temp. comp.:	Automatic
Electronics temp.:	F: -40° to 160° C: -40° to 71°
Pressure:	30 psi (2 bar)
Enclosure rating:	NEMA 4
Enclosure mat.:	Aluminum
Window mat.:	Glass
Transducer mat.:	PVDF
Process mount:	2" NPT
Conduit entrance:	Dual, 1/2" NPT
Compliance:	RoHS
Classification:	Explosion proof
Approvals:	FM: Class 1, Div 1, Groups A, B, C, D Class II/III, Div 1, Groups E, F, G

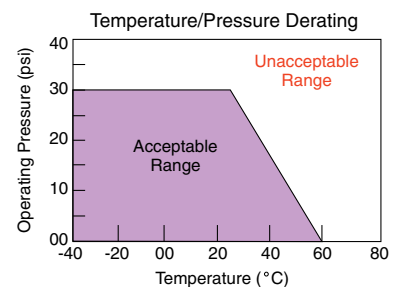
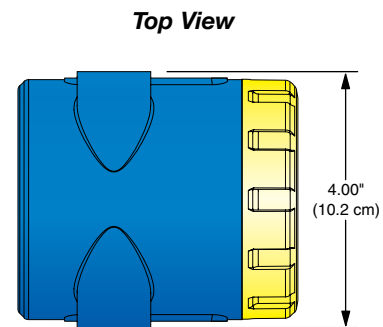
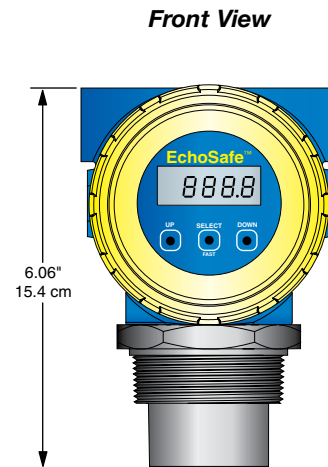
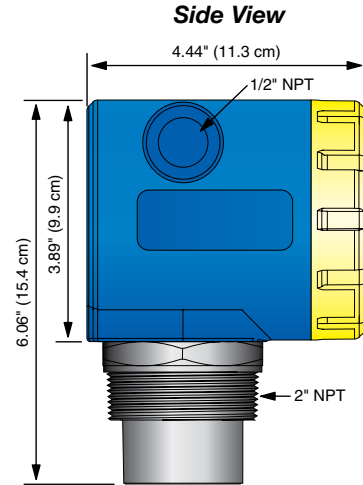



SAFETY

Step Two

 **About this Manual:** PLEASE READ THE ENTIRE MANUAL PRIOR TO INSTALLING OR USING THIS PRODUCT. This manual includes information on the XP8_-0 Ultrasonic Level Transmitter from FLOWLINE. Please refer to the part number located on the transmitter label to verify the exact model configuration which you have purchased.

 **User's Responsibility for Safety:** FLOWLINE manufactures a broad range of level sensing technologies. While each of these sensors is designed to operate in a wide variety of applications, it is the user's responsibility to select a sensor model that is appropriate for the application, install it properly, perform tests of the installed system, and maintain all components. The failure to do so could result in property damage or serious injury.

 **Proper Installation and Handling:** Only properly trained staff should install and/or repair this product. Never overtighten the transmitter within the fitting. Always check for leaks prior to system start-up.

 **Opening The Enclosure:** EchoSafe is designed to be installed in a hazardous areas and, when installed, do not open the unit while power is applied. Always disconnect the power source from EchoSafe prior to opening, programming, installing, or removing it. Additionally, ensure that electrical wiring, fittings and mechanical connections conform to all applicable electrical codes.

 **Material Compatibility:** The XP8_ series enclosure is made of a Aluminum. The transducer is made of Polyvinylidene Fluoride (PVDF). Make sure that the model which you have selected is chemically compatible with the application media and it's environment.

 **Enclosure:** While the transmitter housing is liquid-resistant the XP8_ series is not designed to be operational when immersed. It should be mounted in such a way that the enclosure and transducer do not come into contact with the application media under normal operational conditions.

 **Make a Fail-Safe System:** Design a fail-safe system that accommodates the possibility of transmitter and/or power failure. FLOWLINE recommends the use of redundant backup systems and alarms in addition to the primary system.

OVERVIEW

Step Three

A. Application: The explosion proof ultrasonic transmitter provides non-contact level detection up to 32.8' or 10m. The transmitter is well suited for a wide range of corrosive, waste and slurry type media, and is broadly selected for atmospheric bulk storage, day tank and waste sump applications.

B. Part Number: The part and serial numbers are located on the wrench flat. Check the part number on the product label and confirm which of the below model configurations you have purchased:

Part Number	Range	Supply	Mount
XP88-0	24.6' (7.5 m)	18-28 VDC	2" NPT
XP89-0	32.8' (10 m)	18-28 VDC	2" NPT

Handling Static-Sensitive Circuits/Devices



When handling the transmitter, the technician should follow these guidelines to reduce any possible electrostatic charge build-up on the technicians body and the electronic part.

1. Always touch a known good ground source before handling the part. This should be repeated while handling the part and more frequently after sitting down from a standing position, sliding across the seat or walking a distance.
2. Avoid touching electrical terminals of the part unless making connections.

PREPARATION

Step Four

A. Supply Voltage: The transmitter power supply voltage should never exceed a maximum of 28 VDC. Flowline controllers and meters have built-in 24 VDC power supplies for use with the transmitter. Alternative controllers and/or power supplies with a minimum output of 18 VDC may also be used with the transmitter for calibration and/or operation.

B. Factory Span: All transmitter models are factory calibrated with 4 mA at their maximum range (tank empty) and 20 mA at their minimum range (tank full). The 4 and 20 mA span set points can be reverse calibrated on all models.

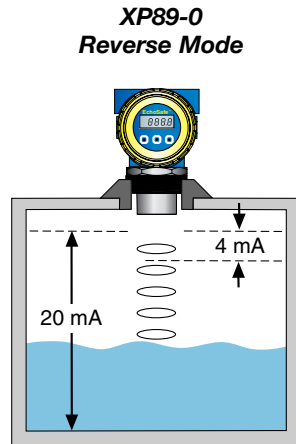

C. Maximum Applied Range: The Individual or cumulative effects of agitation or vapor can reduce the overall quality of signal return and shorten the maximum applied range of the transmitter. To determine the maximum applied range of the transmitter in your application, refer to the below de-rating chart.

Maximum Applied Range De-rating Chart

XP88/89-0

Agitation = 1-3 @ 50 kHz

Vapor = 3-5 @ 50 kHz

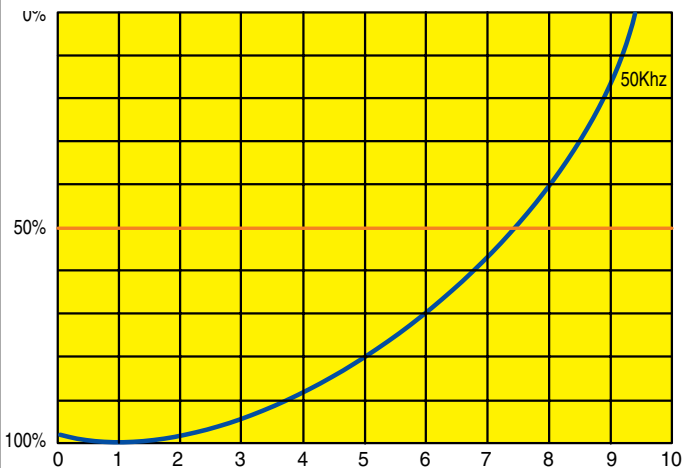

MENU ITEMS

Step Five

A. WARM UP: This is the initial power up mode. When this message is displayed, the transmitter is going through its power up routine, and validating the target value. After a short period of time, this message will disappear and be replaced by a numeric value.

B. FULL: Level has reached the programmed FULL set point.

C. EMPTY: Level has reached the programmed EMPTY set point.

D. UNITS: Selectable in inches centimeters, feet, meter or percent. The factory default is Inches.

E. INCHES: Inch units of measurement.

F. CM: Centimeters units of measurement.

G. FEET: Feet units of measurement.

H. METERS: Meter units of measurement.

I. PERCNT: 0-100% units of measurement. Percent is the calculated value based on the 4mA and 20mA set points.

J. TANK: Menu through which the 4-20 mA span is adjusted.

K. HEIGHT: The point in inches, feet, meters, or centimeters from the transducer face where the output will be 4 mA (generally the bottom of the tank). Factory default is the same as the unit's maximum range. Example: XP88 = 295" maximum range which is also the same 4 mA set point under factory default.

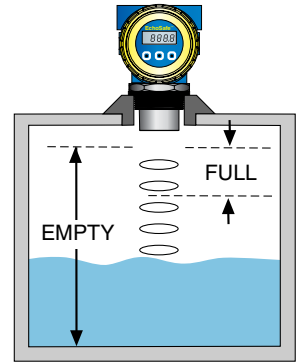

L. Fill H (Fill Height): The point in inches, feet, meters or centimeters from the bottom of the tank to the high level where the output will be 20 mA (generally the straight wall distance from the bottom of the tank). NOTE: The transmitter dead band is automatically subtracted from the FILL H. Example: XP88 = 8" dead band. Therefore the maximum FILL H is 295" [maximum range] - 8" [dead band] = 287".

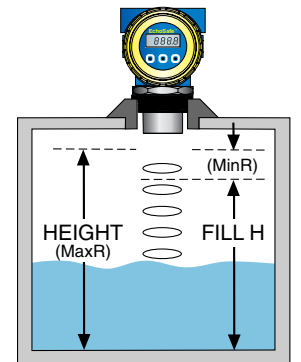

M. REV mA (Reverse mA): Allows the user to select 20 mA at the bottom and 4 mA at the top of the tank (20-4 mA). Factory default is 4 mA (MaxR) at the bottom and 20 mA (MinR) at the top.

N. NORM: Sets EchoSafe so 4 mA is at the bottom of the tank and 20 mA at the top. This is the default settings.

O. REV: Sets EchoSafe so 20 mA is at the bottom of the tank and 4 mA at the top.

MENU ITEMS

Step Six

P. SAFE: The FAIL-SAFE current output of the transmitter if the acoustic signal is LOST. Selectable at 4 mA, 20 mA, 21 mA, 22 mA or HOLD. (HOLD is the last 4-20 mA value prior to LOST).

Q. HELP: Allow the user to view the current configuration settings in EchoSafe.

R. SETUP: Displays the present configuration settings such as UNITS, HEIGHT, FILL H, SAFE, REV.

S. TEST P: Allows the user to view the test parameters of SEGMENT CHECK, RANGE, ECHO, POWER, VER.

T. SEGMENT CHECK: Tests all LED segments for operation.

U. RANGE: Displays the current inch, centimeter, feet, meter or Percent measured value.

V. ECHO: Displays the present acoustic signal strength.

W. POWER: Displays the present acoustic power level

X. VER (VERSION): Displays the transmitter software version.

Y. R ALL: Allows the user to reset the transmitter to its original factory default settings

Z. ERROR: Indicates that the new value has NOT been saved in memory (after depressing the SELECT/FAST or EXIT key).

AA. RUN: When displayed, if the user depresses the SELECT/FAST key, the transmitter will exit the programming mode and return to the RUN mode for normal operation.

BB. UP / DOWN: Increases or decreases the SET 20 and SET 4 display values in the programming mode. NOTE: Simultaneously holding down the SELECT/FAST button while pressing the UP or DOWN button will increase the speed of the display.

PROGRAMMING

Step Seven



EchoSafe is designed to be installed in a hazardous areas, and when installed, do not open the unit while power is applied. Always disconnect the power source from EchoSafe prior to opening, programming, installing or removing it.

A. Introduction: The transmitter has two modes, RUN and MENU. In the RUN mode, the transmitter is operational and the display will indicate the liquid height in inches, centimeters or percent.

In the MENU mode, the display will indicate the selected mode of calibration. The transmitter arrives from the factory with its settings at 4 mA = maximum range and 20 mA = minimum range (defined by the dead band or minimum measurement distance). The transmitter is programmed with it's built-in display and three button keyboard.

B. Entering the Program Mode: Press and hold the

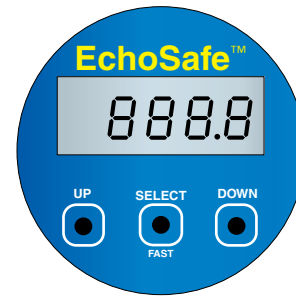

SELECT/FAST button for approximately 5 seconds until the display changes from a numeric value to MENU, indicating that you have entered the MENU mode.

Note: When MENU mode is active, the EchoSafe will hold the last current value. The value will not change until the transmitter is returned to RUN Mode.



After entering the MENU mode, the display will scroll through the top menu, alternately flashing UNITS, TANK, OUTPUT, HELP and RUN.

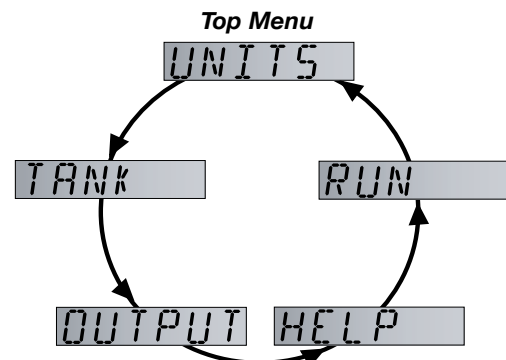

PROGRAMMING

Step Eight

C. Programming UNITS: To change UNITS from INCHES to CM or PERCENT.

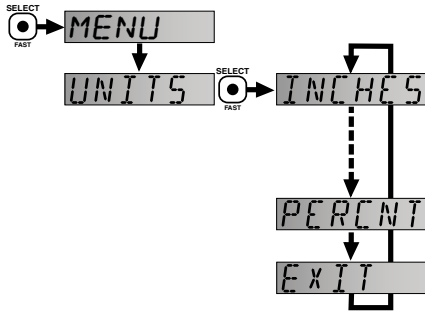

1. Press the SELECT/FAST button and hold it for 5 seconds until MENU appears.
2. When UNITS appears, press the SELECT/FAST button. The display will rotate between INCHES, CM,, FT, M, PERCENT and DISPLAY.
3. Press the SELECT/FAST button when the UNITS you want (INCHES, CM, FT, M or PERCENT) appear. The display will then display SAVED.

You have successfully changed the UNITS function.

Note: Percent units can only be selected after the transmitters Height (4 mA) and Fill H (20 mA) set points have been programmed. Therefore initial programming should always be done in INCH, CM, FT or M UNITS.

D. Programming Off Tank: If you know the dimensions of your tank, you may input the 4 mA and 20 mA set points manually. To do so, review the following:

HEIGHT: The point in inches or centimeters from the transducer face where the output will be 4 mA (generally the bottom of the tank). Factory default is the same as the unit's maximum range. Example XP88 = 295" maximum range which is also the same 4 mA set point under factory default.

FILL H: The point in inches or centimeters from the bottom of the tank to the high level where the output will be 20 mA (generally the straight wall distance from the bottom of the tank). NOTE: The transmitter dead band is automatically subtracted from the FILL H. Example: XP88 = 8" dead band. Therefore the maximum FILL H is 295" [maximum range] - 8" [dead band] = 287".

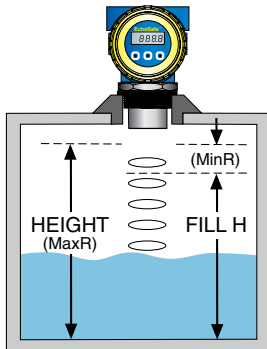

PROGRAMMING

Step Nine

E. Programming HEIGHT: To change HEIGHT 4 mA value.

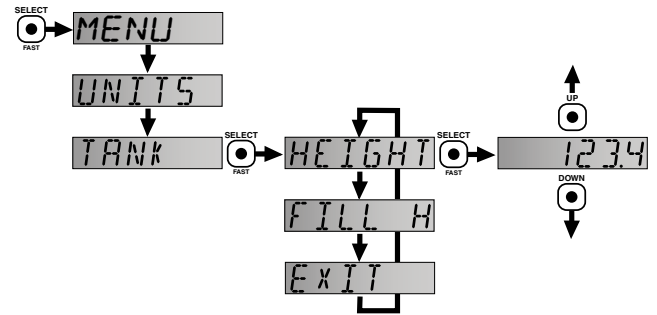

1. Press the SELECT/FAST button and hold it for 5 seconds until MENU appears.
2. When TANK appears, press the SELECT/FAST button. The display will rotate between HEIGHT, FILL H and EXIT.
3. When HEIGHT appears, press the SELECT/FAST button. The display will show a decimal reading in the selected UNITS.
4. Press the UP/DOWN buttons to increase or decrease this value. This value is the distance from the transducer face to the bottom of the tank. NOTE: Simultaneously holding down the SELECT/FAST button while pressing the UP or DOWN button will increase the speed of the display.
5. When you have reached the desired value, press SELECT/FAST to SAVE.

You have successfully programmed the HEIGHT or 4 mA value.

F. Programming FILL H: To change FILL H 20 mA value.

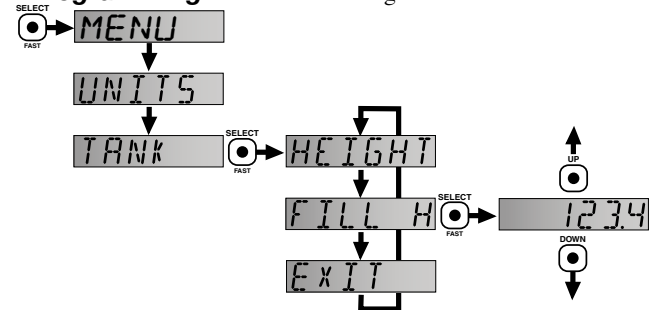

1. Press the SELECT/FAST button and hold it for 5 seconds until MENU appears.
2. When TANK appears, press the SELECT/FAST button. The display will rotate between HEIGHT, FILL H and EXIT.
3. When FILL H appears, press the SELECT/FAST button. The display will show a decimal reading in the selected UNITS.
4. Press the UP/DOWN buttons to increase or decrease this value. This value is the distance from the bottom of the tank to the full point (typically the straight wall height).
5. When you have reached the desired value, press SELECT/FAST to SAVE it.

You have successfully programmed the FILL H or 20mA value.

PROGRAMMING

Step Ten

G. Programming SAFE Mode: To change SAFE mode.

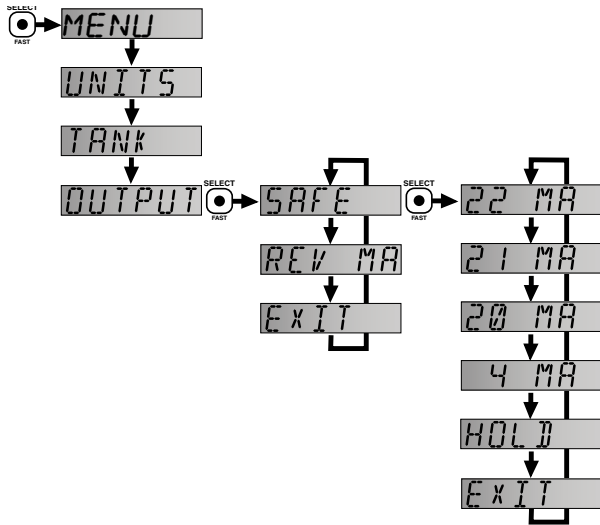

1. Press the SELECT/FAST button and hold it for 5 seconds until MENU appears.
2. When SAFE appears, press the SELECT/FAST button.
3. The display will now rotate through 22mA, 21mA, 20mA, 4mA and HOLD. When you reach the desired setting, press the SELECT/FAST button to SAVE it..

You have successfully programmed the SAFE mode.

PROGRAMMING

Step Eleven

H. Programming REV mA (Optional): In factory default, the transmitter operates with 4 mA at the maximum range, and 20 mA at the dead band. Using the menu item REV mA, you can change the unit to reverse this to 20 mA at the furthest distance and 4 mA at the closest distance.

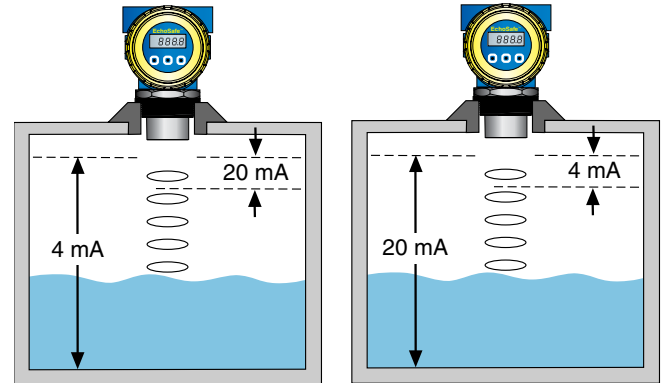

I. Programming REV mA (Mode):

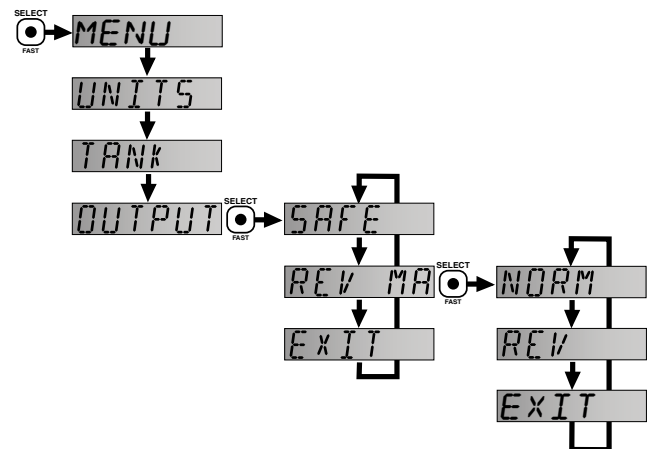

NOTE: You must set HEIGHT and FILL H prior to reversing the 4 and 20 mA. Regardless of which mode you are in (Norm or Rev), changes to the HEIGHT or FILL H are always with respect to the original settings programmed.

NOTE: Any changes to the HEIGHT will effect the FILL H value. The FILL H will stay at the same physical level in the tank. An increase to the HEIGHT value will result in an equal increase to the FILL H value. A decrease to the HEIGHT value will result in an equal decrease to the FILL H value.

PROGRAMMING

Step Twelve

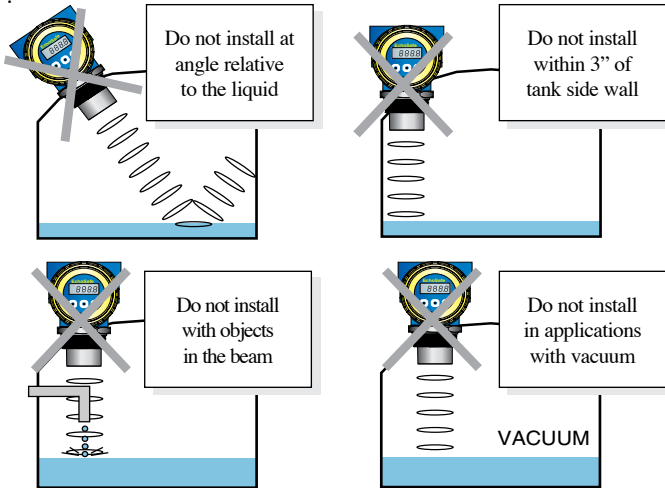

Warning

Flowline Ultrasonic transmitters have been optimized for use in non-metallic fittings. For best performance, avoid the use of metal fittings.

Install the appropriate installation fitting. Make sure that the fitting and transmitter threads are not damaged or worn. Hand tighten the transmitter within the fitting. Perform an installed leak test under normal process conditions prior to system start up.

Gasket

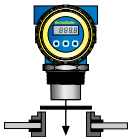

Adapter



Flange

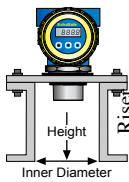

Bracket



Stand Pipe

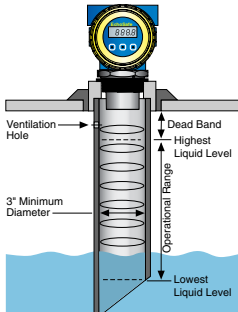

A. Fitting Selection: Check the transmitter part number to determine the required 2" fitting thread type. The transmitter is commonly installed in tank adapters, flanges, brackets or stand pipes.

- 1. Adapter:** Select a tank adapter fitting with minimal height so as to ensure that the installed transducer will not be substantially elevated into the fitting. Avoid tank adapter styles with threads and/or pipe stops forward of the installed transducer.
- 2. Flange:** Tall flanges with narrow risers impede the acoustic signal. Select a fitting with the right riser height versus inner diameter geometry. The transmitter may be elevated up to 12" (30 cm) in a 6" (15 cm) riser, 8" (20 cm) in a 4" (10 cm) riser and 3" (7.6 cm) in a 2" (5 cm) riser.
- 3. Bracket:** The LM50-1001 bracket or equivalent can be used for open tank top installations against the side wall.

4. Stand Pipe: A stand pipe may be used to dampen turbulence or separate surface foam. Select a minimum 3" pipe for the stand pipe. The pipe length should run the measurement span. Cut a 45° notch at the bottom of the pipe and drill a 1/4" pressure equalization hole in the dead band.

INSTALLATION

Step Thirteen

A. Wiring: A supply voltage of 18 - 28 VDC is used to power the XP8_ series. The sensor circuit should never exceed a maximum of 28 volts DC. Electrical wiring of the sensor should be performed in accordance with all applicable national, state, and local codes.

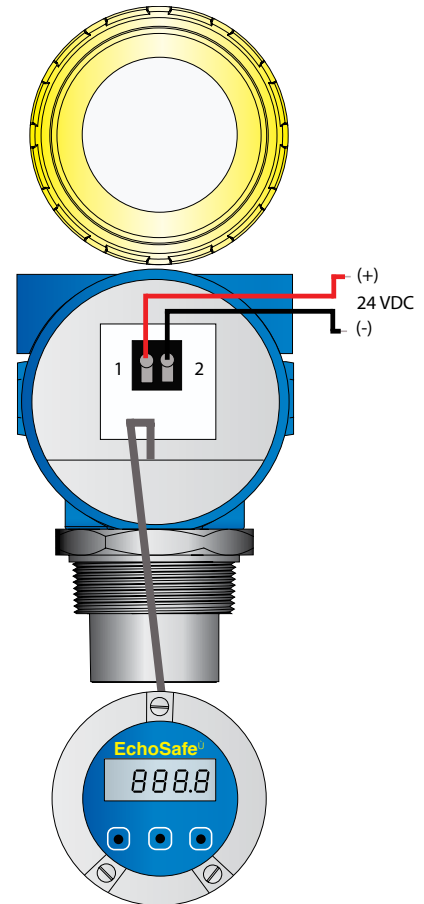

Opening The Enclosure: EchoSafe is designed to be installed in a hazardous areas and, when installed, do not open the unit while power is applied. Always disconnect the power source from EchoSafe prior to opening, programming, installing, or removing it. Additionally, ensure that electrical wiring, fittings and mechanical connections conform to all applicable electrical codes.

TROUBLESHOOTING

Step Fourteen

A. Viewing Programmed VALUES:

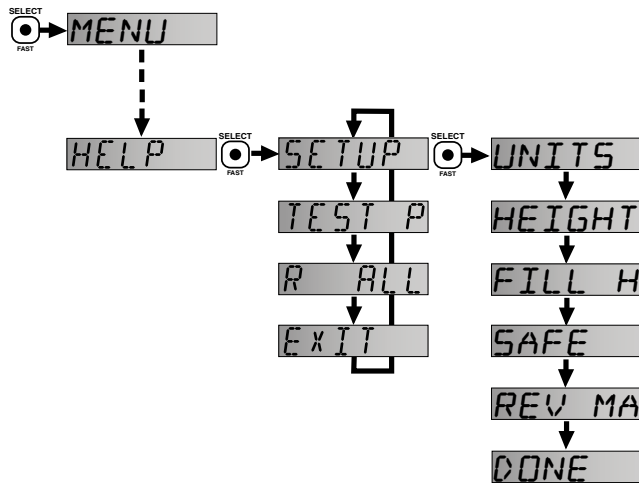

1. Press the SELECT/FAST button and hold it for 5 seconds until MENU appears.
2. When HELP appears, press the SELECT/FAST button. The display will rotate between SETUP, TEST P and R ALL.
3. When SETUP appears, press the SELECT/FAST button. You will now begin viewing calibration settings (UNITS, HEIGHT, FILL H, SAFE, REV mA) that are programmed in the transmitter.

When complete the display will revert back to the HELP menu.

B. Viewing TEST P:

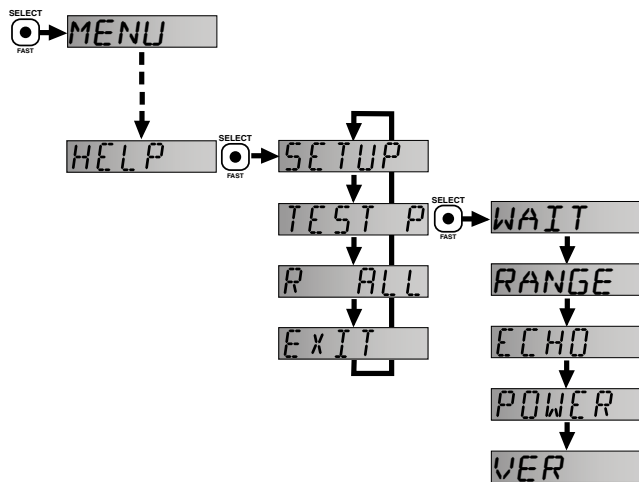

1. Press the SELECT/FAST button and hold it for 5 seconds until PROG appears.
2. When VALUES appears, press the SELECT/FAST button. The display will rotate between SETUP, TEST P and RESET.
3. When DIAG appears, press the SELECT/FAST button. You will now begin viewing diagnostic values (LEVEL, TEMP ECHO, POWER, MOUNT and VER) that may be relevant to the transmitter and it's performance in your application.

When complete the display will revert back to the VALUES menu.

TROUBLESHOOTING

Step Fifteen

C. Factory RESET:

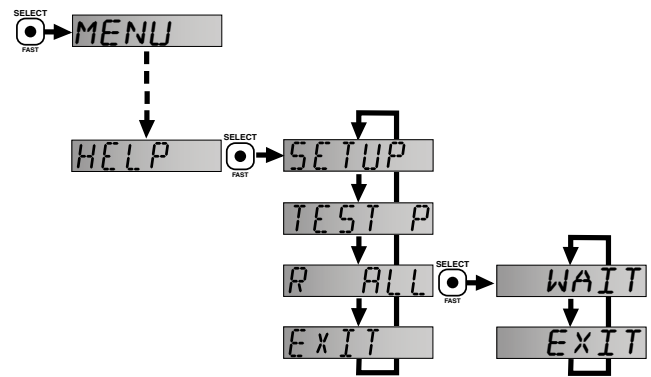

1. Press the SELECT/FAST button and hold it for 5 seconds until MENU appears.
2. When HELP appears, press the SELECT/FAST button. The display will rotate between SETUP, TEST P and R ALL.
3. When R ALL appears, press the SELECT/FAST button.
4. Unit will reset.

Note: FACTORY RESET resets the transmitter back to its original factory default settings: (20 mA = Minimum Range, 4mA = Maximum Range and SAFE = 22mA).

D. Testing the Transmitter

Factory Set Points		
Transmitter	4 mA Setting	20 mA Setting
XP88-0	26.4 (7.5m)	8 (20 cm)
XP89-0	32.8 (10m)	12 (30 cm)

1. Connect a multi-meter in series with the black wire to read the current output.
2. Verify that the current increases (tank filling) and decreases (tank emptying) appropriately in the calibrated span.
3. If not, carefully observe and attempt to correlate any installation, level or application event for more specific troubleshooting.
4. Write down the information in TEST P (SEGMENT, RANGE, ECHO, POWER, VER) and have it ready when you contact your Flowline representative.

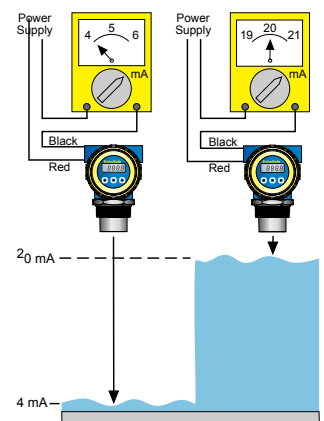

E. Additional Information: Go to www.flowline.com and click on the nav-bar "Application Info" button for FAQ's, tech-tips, case studies, white papers, glossary and success stories.