

Switch-Tek™ Horizontal High-Temp Float Switch

Switch-Tek High-Temp LH30 0504 DS1_0

Specifications

Orientation:	± 20° vertical
Accuracy:	± 3 mm in water
Repeatability:	± 1 mm in water
Specific gravity:	0.8 min.
Contact type:	(1) SPST reed
Contact rating:	240 VAC/VDC @ 20 VA
Contact output:	Selectable NO/NC
Process temp.:	F: -40° to 300° C: -40° to 148.9°
Pressure:	300 psi max. (20.7 bar max.)
Sensor rating:	NEMA 4 (IP65)
Sensor material:	316 ss
Process mount:	1/2" NPT
Wire type:	2-wire, #22 AWG
Wire length:	24" (61 cm)
Wire jacket mat.:	Polymeric
Classification:	General purpose
CE compliance:	EN 50082-2 immunity EN 55011 emission EN 61010-1 safety

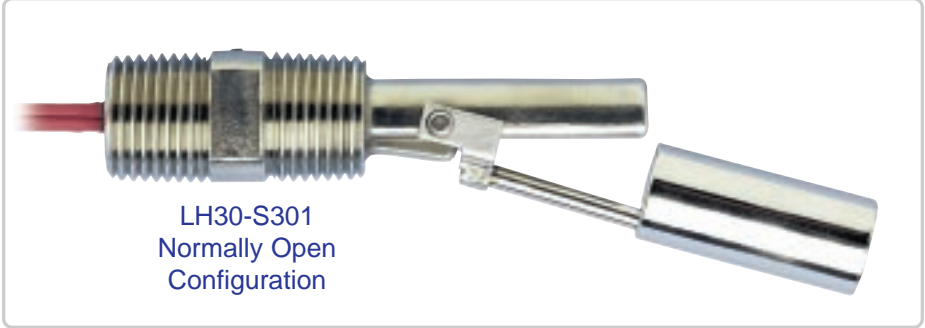

Description

The general purpose high-temp float level switch is an ideal choice for relatively clean water, diluted chemical or petroleum based liquids with non-coating and/or scaling characteristics. Media examples include hot machine oil and pickling solutions. The dry contact closure provides a reliable switch interface with remote devices such as a PLC, SCADA or alarm. The sensor mounts horizontally through the side wall of the tank. The high temperature float switch is easily configured for NO or NC states based on the installed orientation of the sensor and the resulting float movement relative to the liquid level. In a NO state, the float lowers with the liquid, and in a NC state, the float rises with the liquid.

Features

- ✓ High temperature and pressure 316 SS float and stem design
- ✓ Dual threaded design for flexible inside-out or outside-in installation
- ✓ 20 VA dry contact with selectable NO or NC state via float orientation

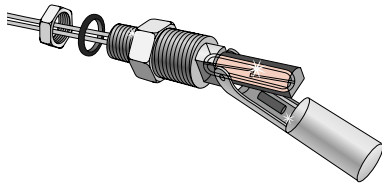

Dimensions

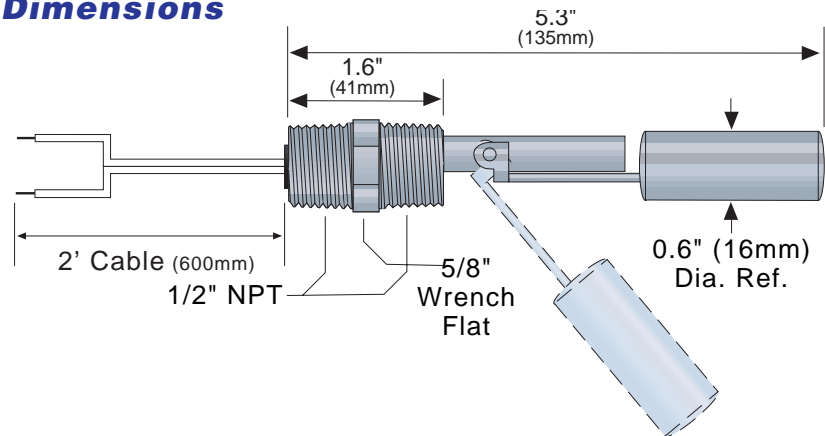

N.O. - Dry

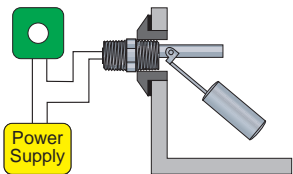

N.O. - Wet

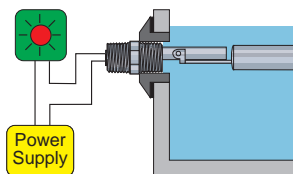

N.C. - Dry

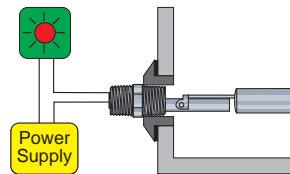

N.C. - Wet

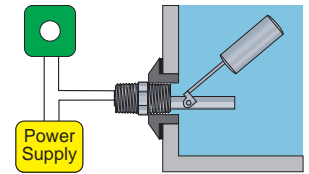

Horizontal Float Ordering

CE

LH3 -S301

Ordering Notes

(1) The normally open or closed contact output is selectable based on the installed 12:00 or 6:00 sensor orientation.

Maximum pressure (1)
0 300 psi (20.7 bar)

FLOWLINE

10500 Humbolt Street • Los Alamitos, CA 90720 • www.flowline.com • T (562) 598-3015 • F (562) 431-8507